

RTB 100 PHOENIX

DATASHEET/DATABLAD

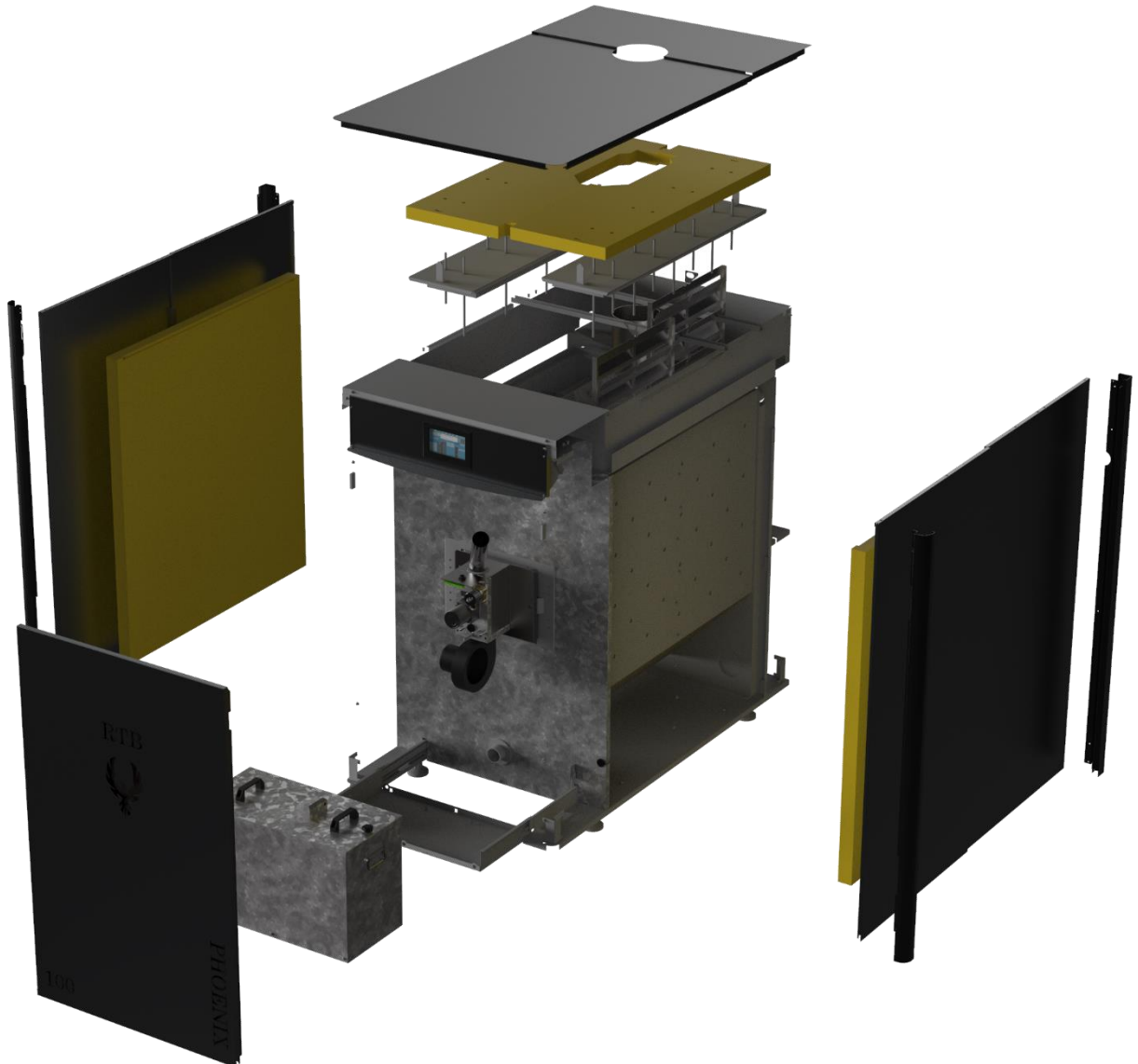

DATASHEET/DATABLAD

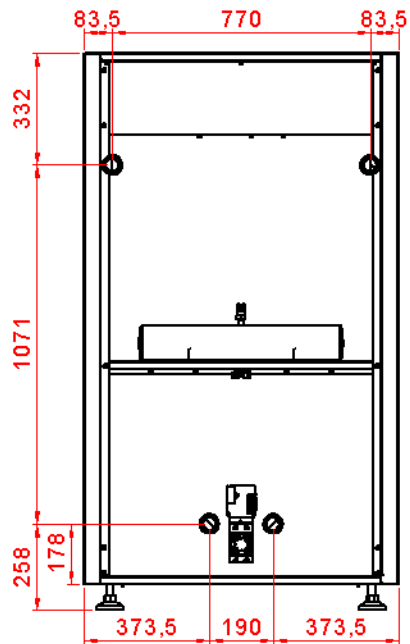
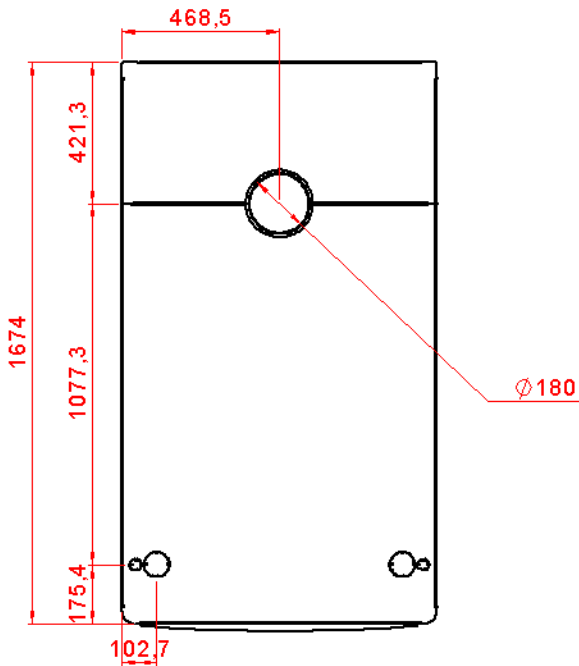
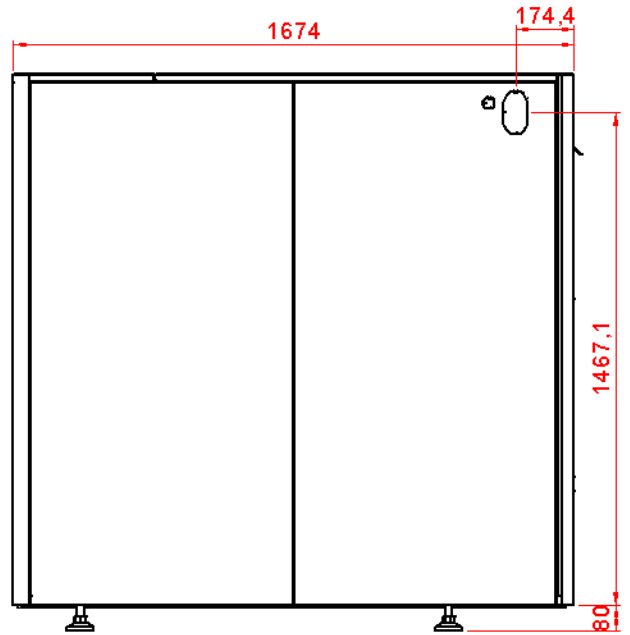
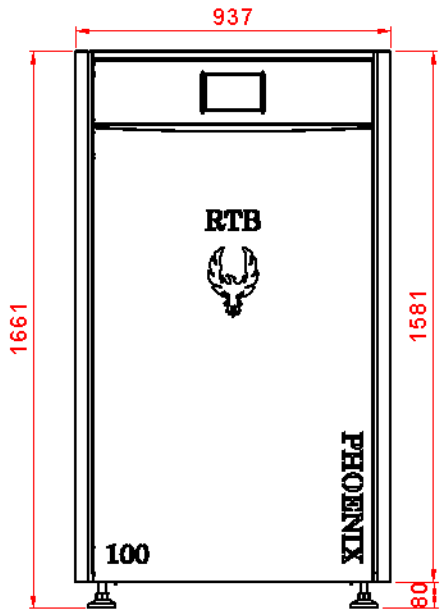

DATASHEET/DATABLAD

Product Name	Produkt navn	RTB 100 PHOENIX
SKU	SKU	90130100
Output (kW)	Effekt (kW)	28,4 – 99,7
Design Model	Design Model	PHOENIX
Efficiency Nominal Output	Effektivitet Nominel	93,2 %
Efficiency Low Output	Effektivitet Lavlast	94,4 %
EN303-5:2012 Class	EN303-5:2012 Klasse	5
EN303-5:2012 Test rapport	EN303-5:2012 Test rapport	300-ELAB-2513
Controller:	Styrekontrol	v16
Width, only Boiler (mm)	Bredde, Kun Kedel (mm)	937
Depth (mm)	Dybde (mm)	1674
Height, only Boiler (mm)	Højde, Kun Kedel (mm)	1661
Chimney (mm)	Skorsten (mm)	180
Weight (Kg)	Vægt (Kg)	876
Water Volume (L)	Vand Volume (L)	125
Ash Tray Size (L)	Askeskuffe størrelse (L)	95
Output / Return / Filling	Fremløb / Retur / Påfylding	1 ¼"
Exhaust fan	Røgsuger	Included
Circulation pump	cirkulationspumpe	Not Included
StokerCloud Monitoring	StokerCloud Overvågning	2 years included
Update Via Internet	Opdatering Via Internettet	2 years included
Weather Compensation	Vejr Kompentation	*upto 4 zones
Smoke Temperature Sensor	Røg Temperatur	Included
Pump Control Function	Pumpe Kontrol Funktion	Included
Timer Function	Timer Funktion	Included
E-mail Notification on Alarm	E-mail Besked om Alarm	2 years included
SMS Notification on Alarm	SMS Besked om Alarm	*
Hot Water Priority	Varmt Vand Priotet	*
Water Flow Sensor	Vandgennemstrømning Sensor	*
Return Temperature Sensor	Retur Temperatur Sensor	*
Outdoor Temperature Sensor	Udendørs temperatursensor	*
Vacuum Transport System	Vakuum Transport System	*
Oxygen Control	Oxygen Kontrol	Included
Compressor Cleaning Boiler	Kedel Kompressor Rensning	Included
Compressor Cleaning Burner	Brænder Kompressor Rensning	Included
Low Noise Compressor	Lydsvag Kompressor	Included
Compressor Control Function	Kompressor Kontrol	Included
Ash Removal	Askefjernelse	Included
Ash Compression	Aske Kompression	Included
Ash Drawer	Askeskuffe	Included
Lazer Distance Sensor (pellet level monitoring)	Laser Afstandsmåler	Included
Under Pressure Sensor	Undertryk Sensor	Included
Photosensor	Fotosensor	Included
* Extra accessories required	* Ekstra tilbehør kræves	

