

DATASHEET:

RTB HOPPER 300

PHOENIX

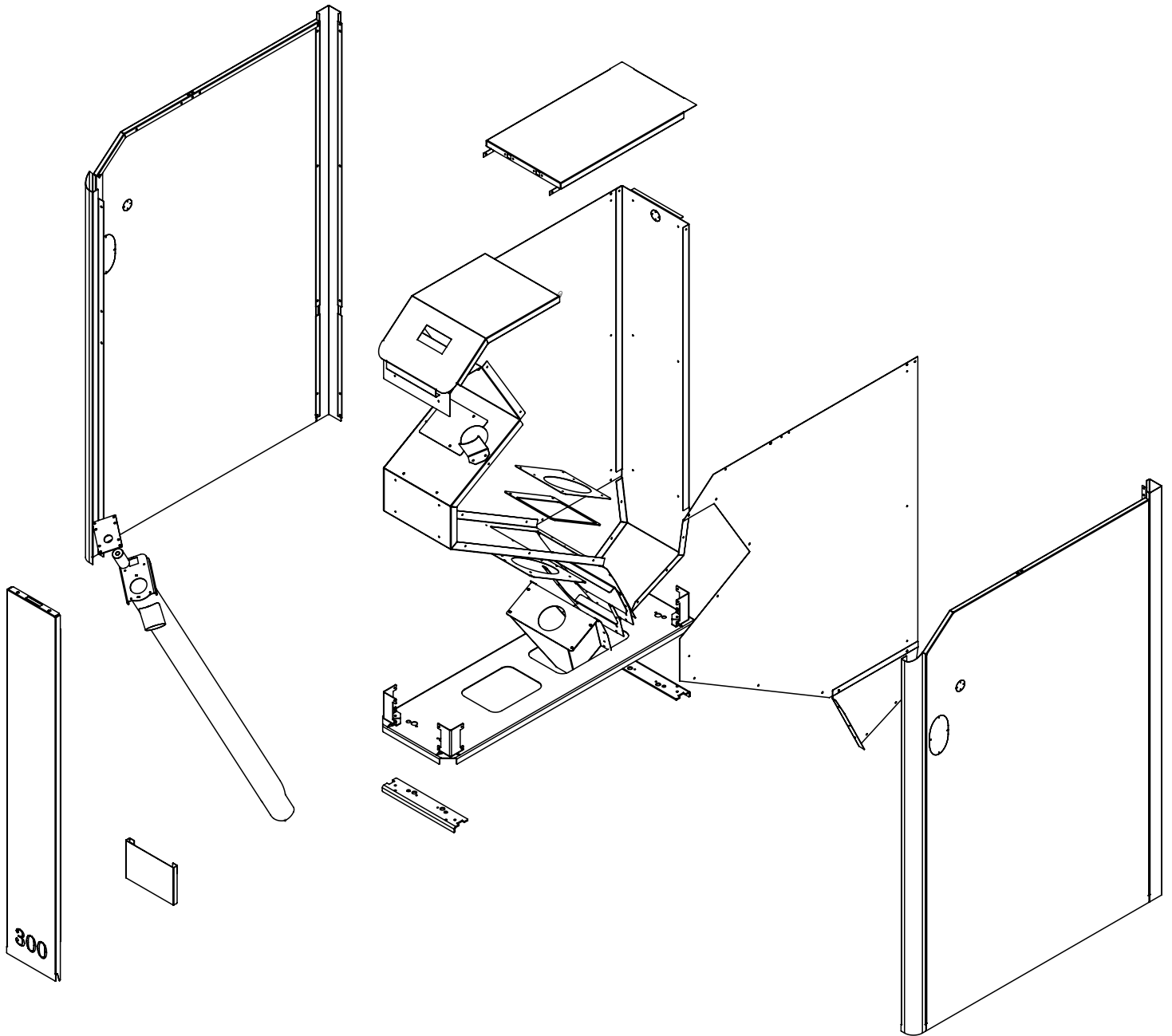



DATASHEET: RTB HOPPER 300 PHOENIX

Product Name	RTB Phoenix Hopper 300
SKU	901120
Compatible w/	RTB 10 Phoenix RTB 16 Phoenix RTB 30 Phoenix
Estimated Capacity (kgs)	130
Capacity (l)	200
Width (mm)	300
Depth (mm)	1000
Height (mm)	1448
Height w/ lid open (mm)	1915
Weight (kgs)	76

